

CODIGO INFORME:
PR-RES-02-B12-218-A-01
 DESCRIPCIÓN INFORME
BLOQUE 12 - Paredes 5 y 6

Levantamiento digital y restitución 2D/3D
 Responsable científico: Prof. Alessandro Merlo
 Colaboradores
 Arq. Francesco Frullini
 Ph.D. Arq. Gaia Lavoratti
 Arq. Giulia Lazzari
 Arq. Elisa Luzzi
 Arq. Michela Notarnicola

Diagnostico de las alteraciones y degradaciones
 Responsable científico: Prof. Susanna Caccia
 Colaboradores
 Ph.D. Arq. Stefania Aimar
 Ph.D. Arq. Leonardo Germani
 Arq. Francesco Pisani
 Ph.D. Arq. Salvatore Zocco

Análisis de la inestabilidad
 Responsable científico: Prof. Michele Paradiso
 Colaboradores
 Lic. Marco Altamura
 Prof. Stefano Galassi
 Arq. Sara Garuglieri

Técnicas e instrumentos para la gestión de obras de restauración y consolidación
 Responsable científico: Prof. Saverio Mecca
 Colaboradores
 Prof. Letizia Dipasquale
 Ing. Vito Getuli

Modelo de información de la construcción (BIM)
 Responsable científico: Prof. Carlo Biagini
 Colaborador
 Ph.D. Ing. Vincenzo Donato

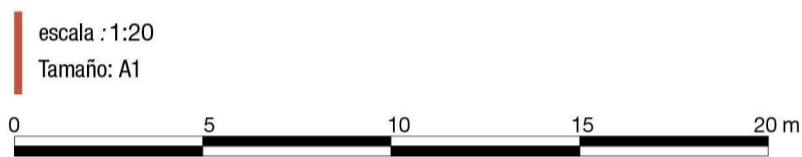
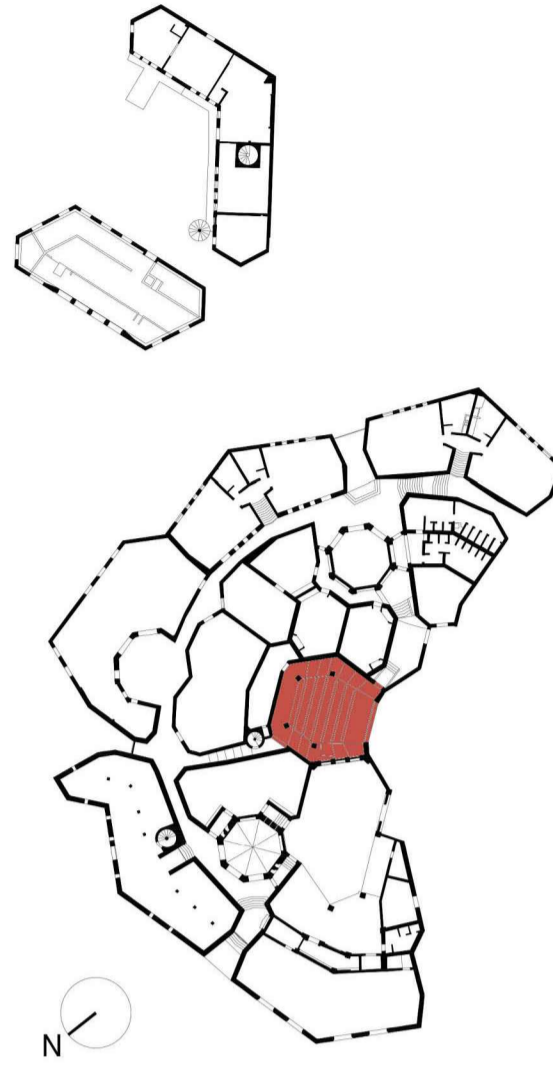

Legenda de los materiales

	Bloques de hormigón		Mortero de revoques pintado
	Hormigón		Metal
	Hormigón pintado		Capa de pintura
	Cerámica		Capa trasparente
	Betún elastómero		Plástica
	Mortero para revoques		Vidrio
	Ladrillo		Mortero de reintegración
	Madera		Mortero de reintegración pintado
	Mortero de unión		Mortero de rejuntado

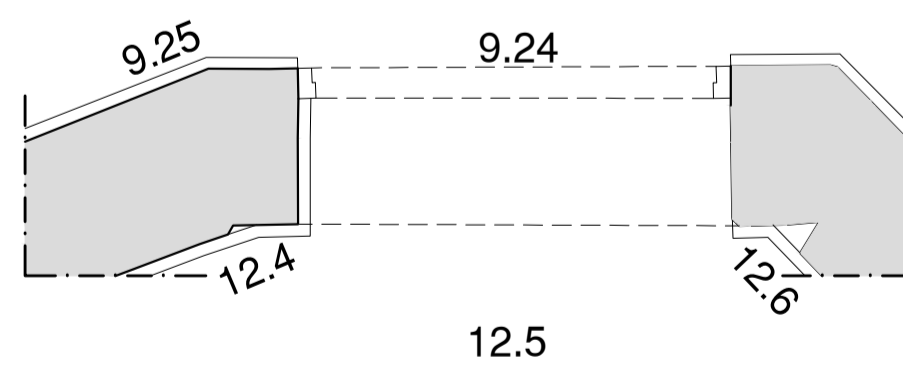
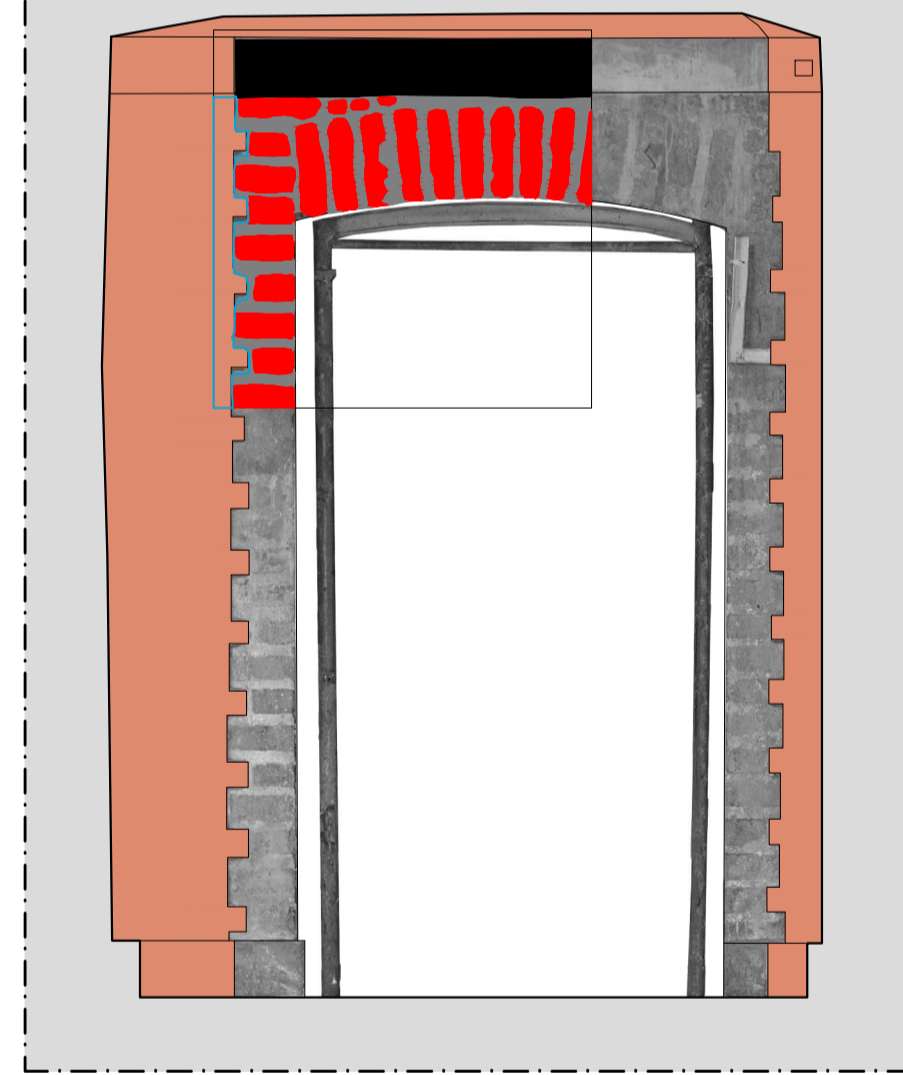
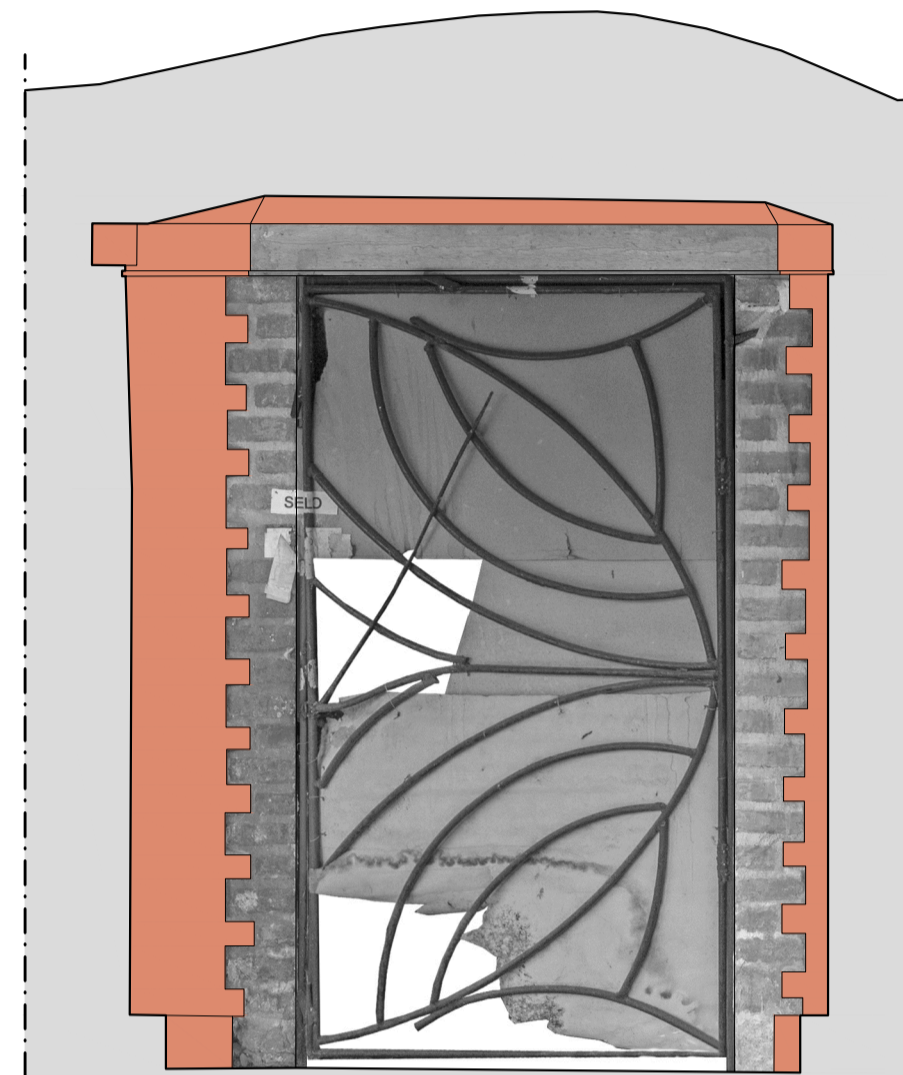

Pared 5

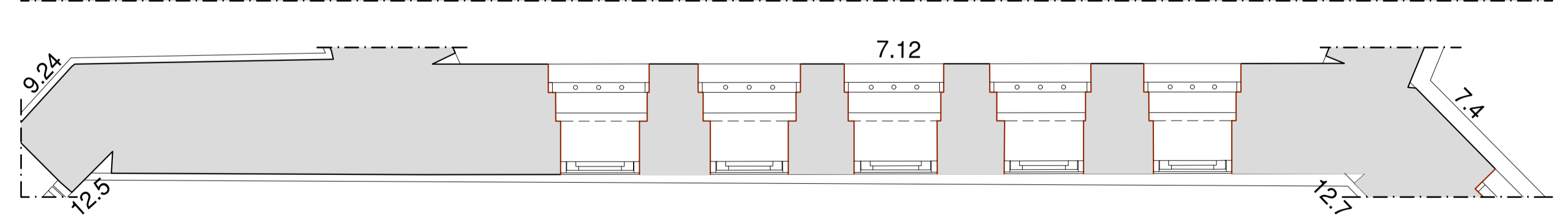
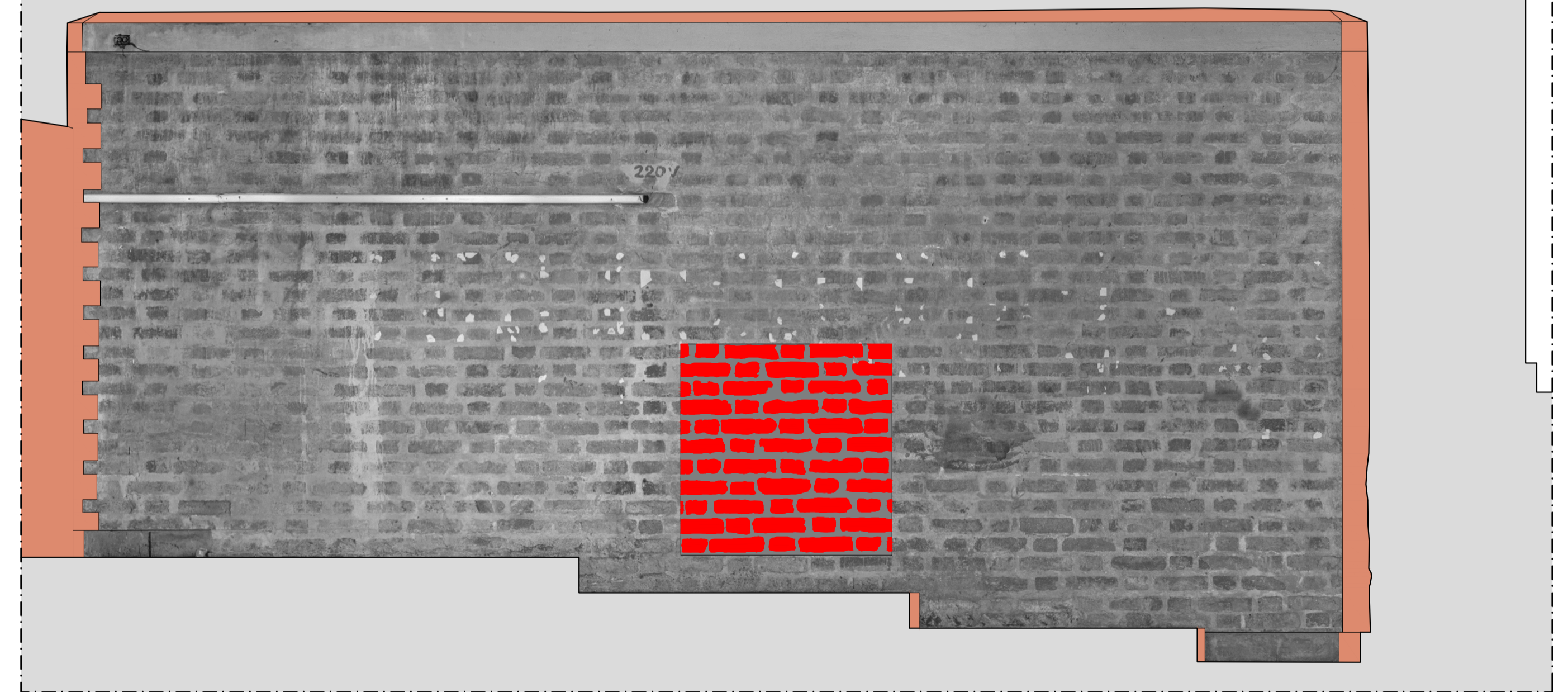
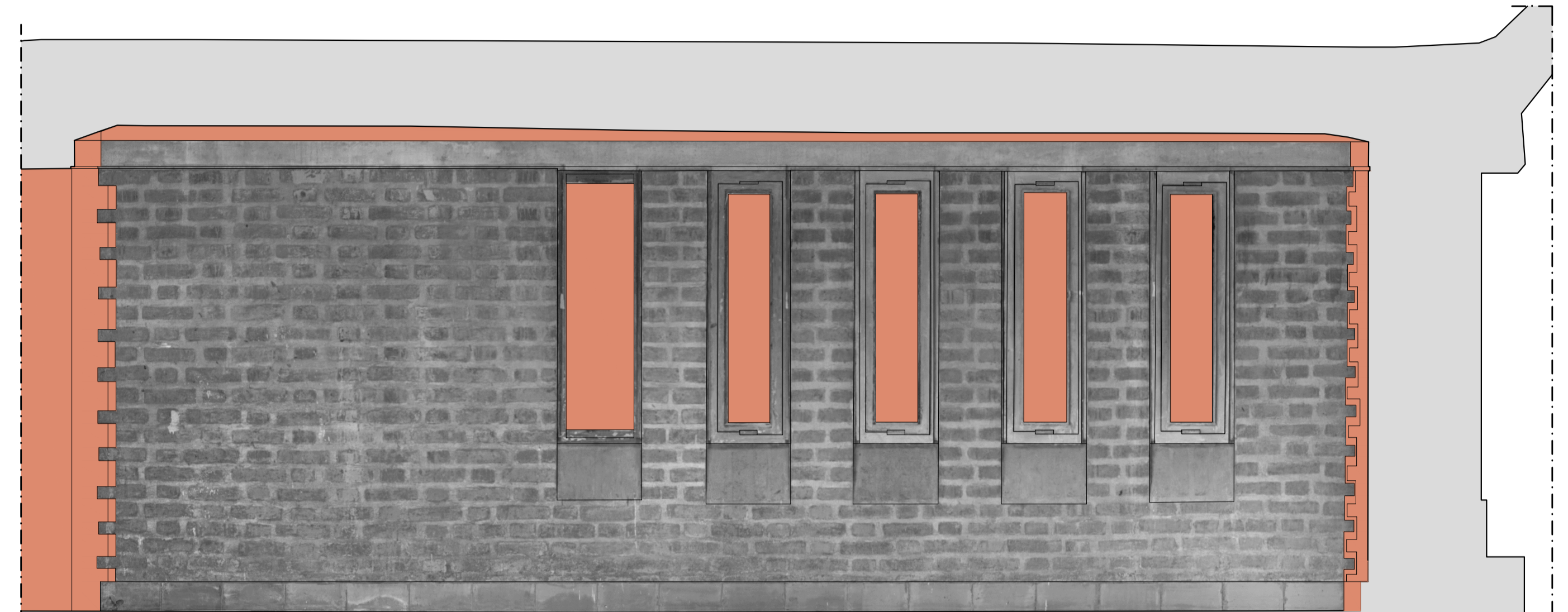

Pared 6